



LAGOM  
THE ESSENCE OF STONE

---



**terratinta** 100%  
ceramiche made in  
Italy



## LAGOM THE ESSENCE OF STONE

<sup>EN</sup>/We live in a fluid age, where we are connected to work 24 hours a day to the detriment of our time: we impatiently wait for answers from our interlocutors at all hours. We are so busy that we forget we have a life. The way out? By deciding together to change our mindsets, behaviours and lifestyles and reclaim the right balance between work and home life. The inspiration comes to us from Sweden. Lagom is the Swedish word for ‘the right amount, neither too much nor too little’. It comes from the phrase “lagom är bäst” which means “the right amount is the best”. The Lagom collection from Terratinta Ceramiche fully embraces this philosophy, treating the natural essence of stone without excess, remaining as true as possible to its identity.

---

<sup>IT</sup>/Viviamo in un’epoca fluida, in cui siamo connessi al lavoro h24 a discapito del nostro tempo personale: aspettiamo impazienti risposte dai nostri interlocutori a tutte le ore. Siamo così occupati da dimenticarci di avere una vita. La via di fuga? Decidere tutti insieme di cambiare mentalità, comportamenti e stile di vita, riappropriandoci del giusto equilibrio fra lavoro e vita domestica.

L’ispirazione ci arriva dalla Svezia. Lagom è la parola svedese che significa “la giusta quantità, né troppo né troppo poco”. Deriva dalla frase “lagom är bäst” che significa “la giusta quantità è la migliore”. La collezione Lagom di Terratinta Ceramiche abbraccia pienamente questa filosofia trattando l’essenza naturale della pietra senza eccessi, mantenendosi fedele quanto più possibile alla sua identità.



## Index | indice

### 05 COLLECTION | Collezione

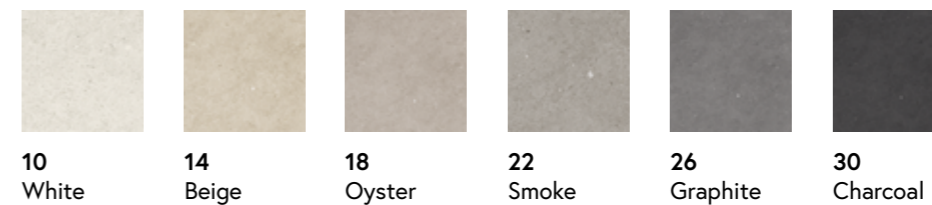

### 32 CURVY



### 38 TERRAZZO

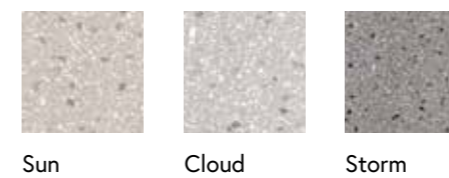

### 44 THICK<sub>20mm</sub>



### 48 atmosfere The unexpected feel Summary

### 56 *Hexa* Summary

### 58 MICROMOSAICS Summary

### 60 Packaging | Imballi

### 62 Technical features | Caratteristiche tecniche



## Collection

# LAGOM

6 COLORS / 2 FINISHES

6 COLORS



WHITE

BEIGE

OYSTER

Thickness | Spessore  
10mm

TERRAZZO

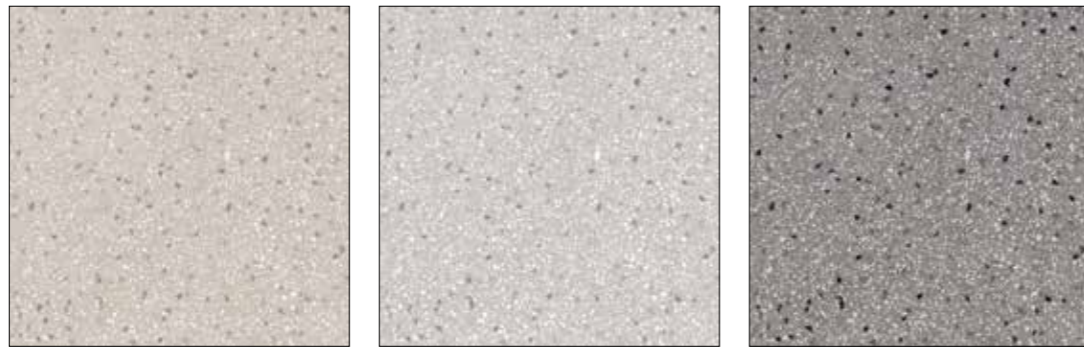

SUN

CLOUD

STORM

Rectified and modular  
Rettificati e modulari

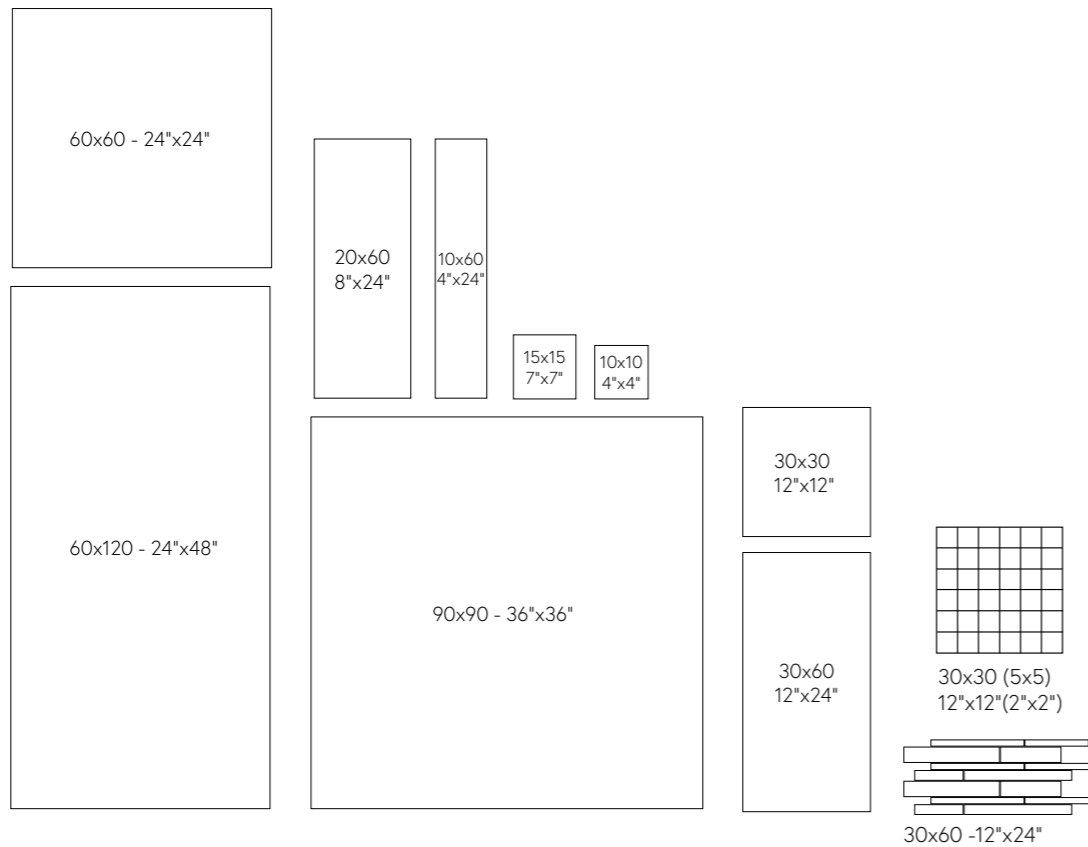

Thickness | Spessore  
10mm



SMOKE

GRAPHITE

CHARCOAL

<sup>EN</sup>/A collection inspired by fine-grained limestone with light colors ranging from White and Beige to the darkest Charcoal. The structure retains visible inclusions of marine residues in its grainy appearance, creating a surface that is particularly popular in contemporary design. This stone-inspired material is particularly suitable for indoor and outdoor use thanks to its neutral tones.

<sup>IT</sup>/Una collezione ispirata alla pietra calcarea a grana fine dalle colorazioni tendenzialmente chiare, che vanno dal White al Beige, fino al più scuro Charcoal. La struttura conserva visibili nell'aspetto granuloso le inclusioni di residui marini, creando una superficie particolarmente apprezzata nel design contemporaneo. Un'ispirazione pietra che grazie alle sue tonalità neutre si dimostra particolarmente adatta per uso interno ed esterno.

FINISHES  
FINITURE

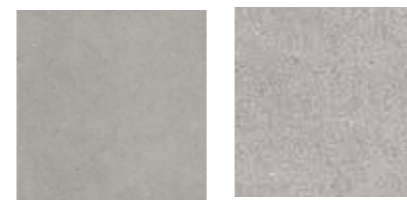

MATT R10 CARVED R11

THICK 20mm  
Ultra matt



BEIGE

90x90 - 36"x36"

OYSTER

90x90 - 36"x36"

SMOKE

90x90 - 36"x36"

Thickness | Spessore  
20mm R11

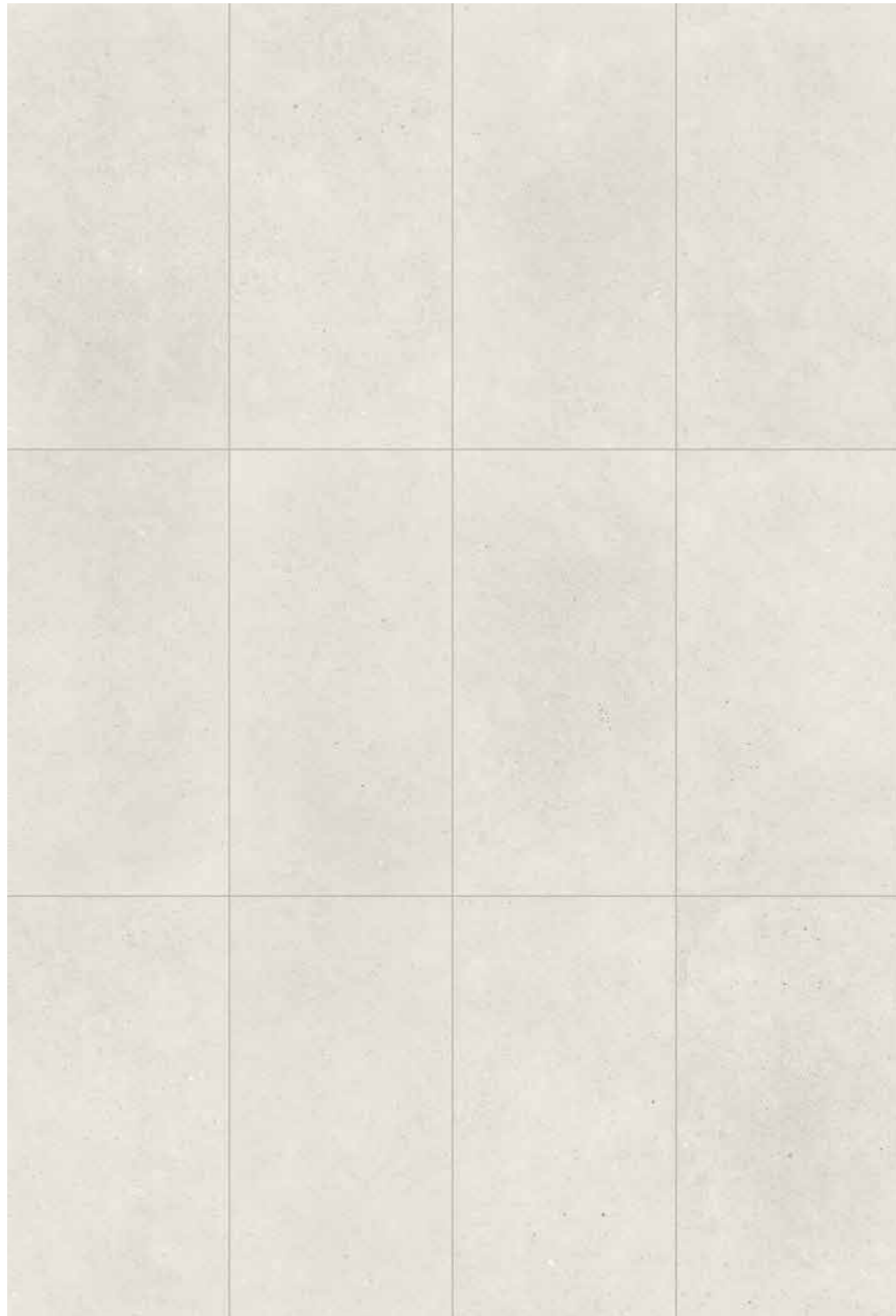

Carved

**WHITE**



Matt

**Available sizes**  
Formati disponibili

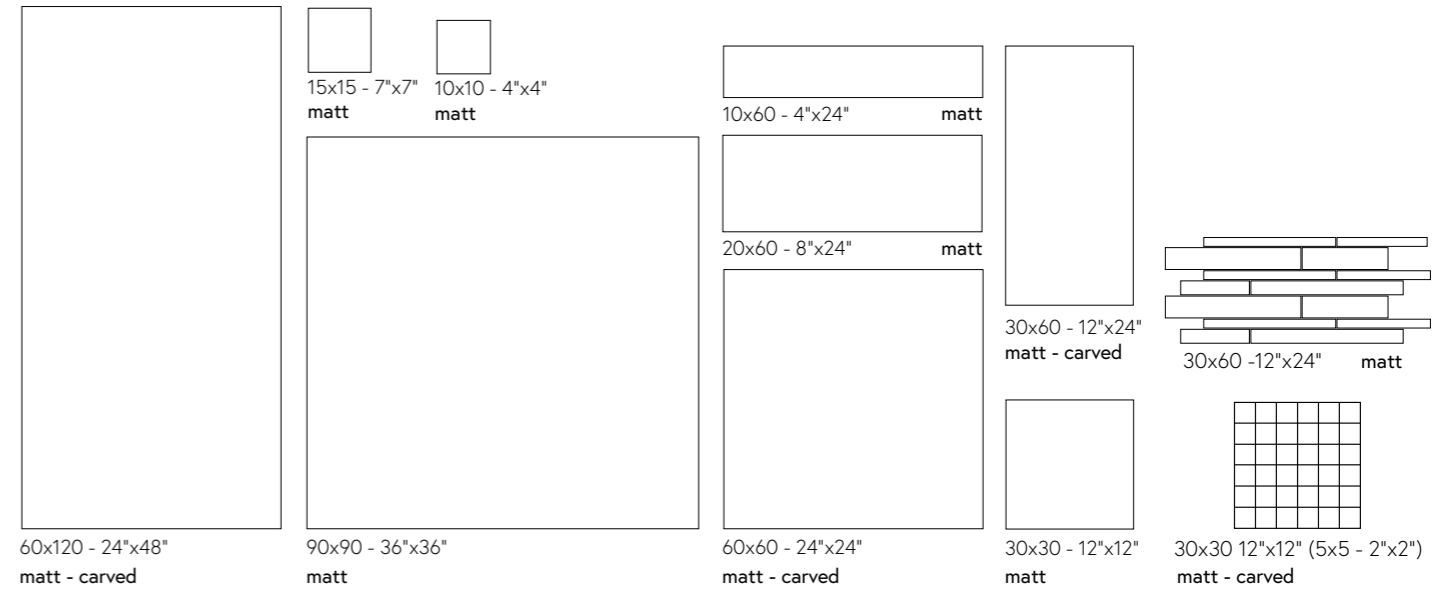



**Lagom**  
floor White 60x60 - 24"x24"



**Lagom**  
floor White 60x60 - 24"x24"



**Available sizes**  
Formati disponibili

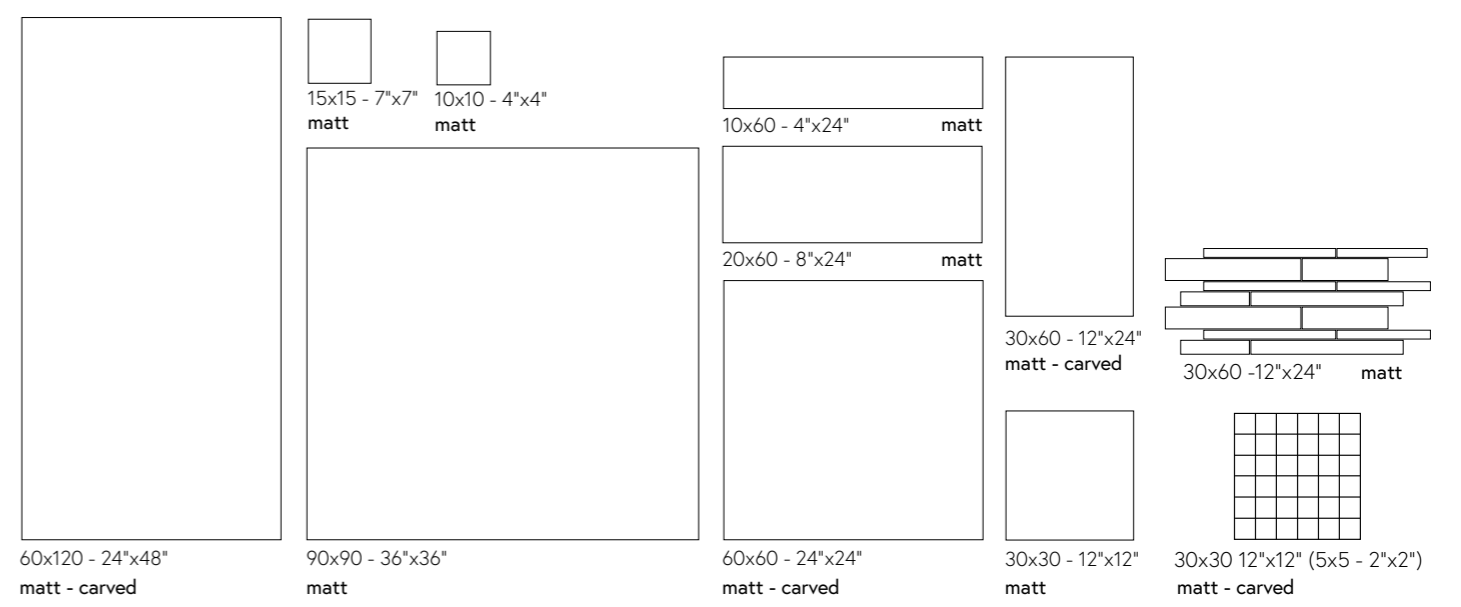





**Lagom**  
floor Beige 90x90 - 36"x36"



**Lagom**  
wall Beige 60x120 - 24"x48"  
Hexa mosaic Dutch White 31,6x31,6 - 12"x12"  
floor Beige 60x60 - 24"x24"



**OYSTER**



**Available sizes**  
Formati disponibili

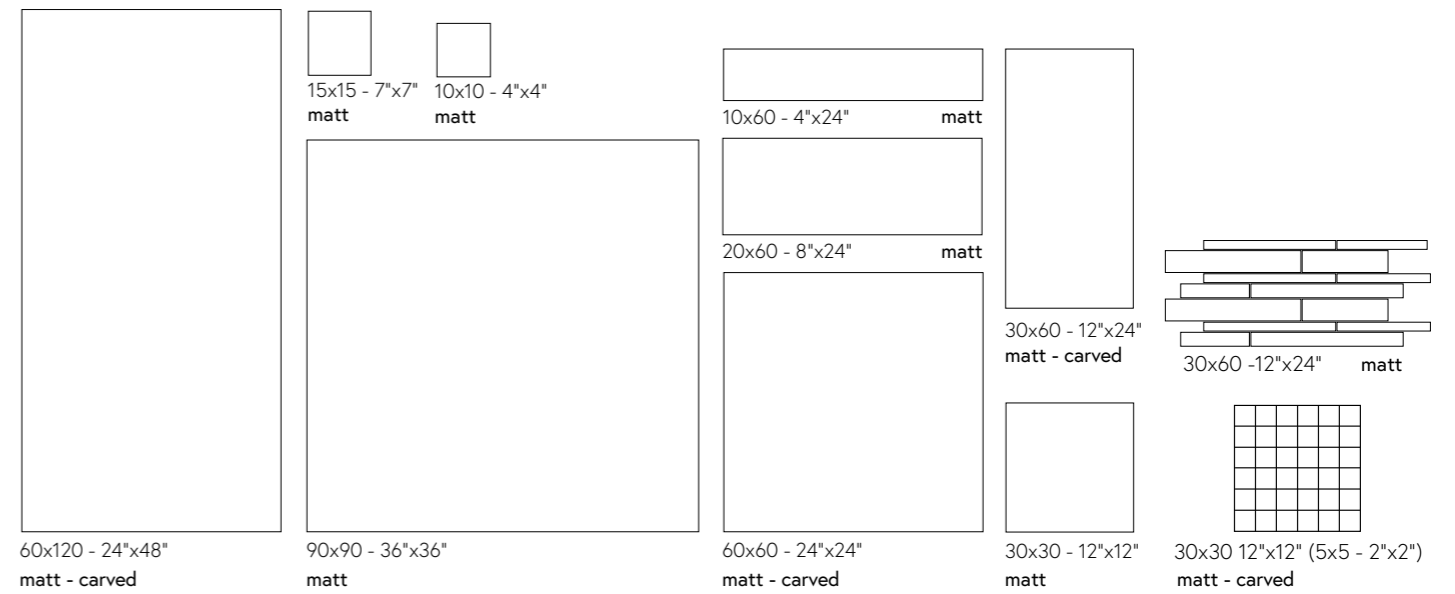

**Lagom**  
Oyster 60x120 24"x48"



**Lagom**  
wall Oyster 60x120 - 24"x48"  
floor Lagom Terrazzo Sun 60x60 - 24"x24"



**SMOKE**



**Available sizes**  
Formati disponibili

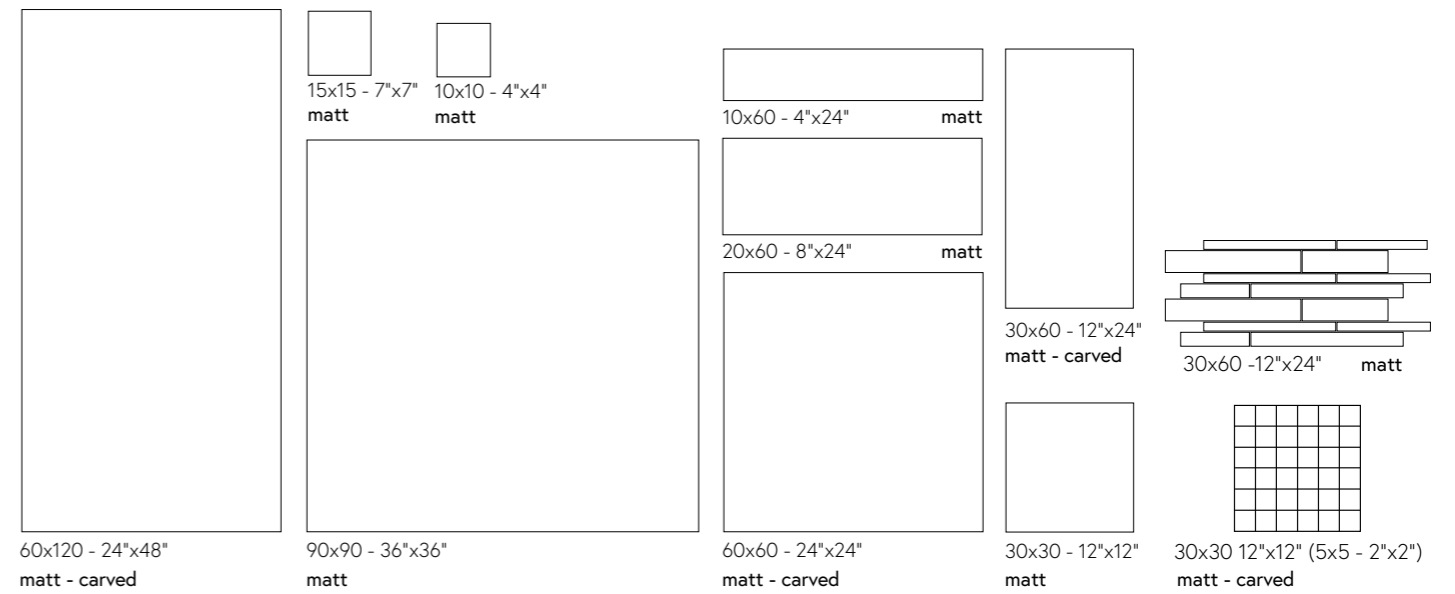



**Lagom**  
wall Smoke 60x120 - 24"x48"  
floor Smoke 60x60 - 24"x24"

**Lagom**  
floor Smoke 60x60 - 24"x24"



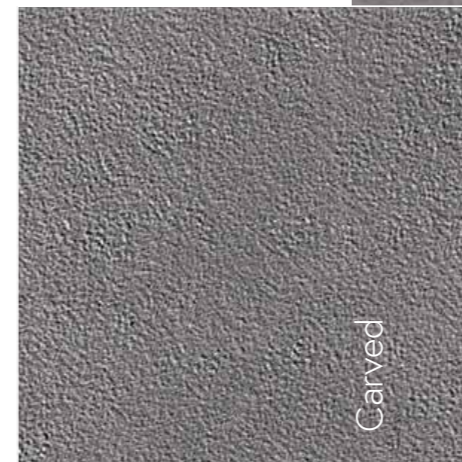

Carved

**GRAPHITE**

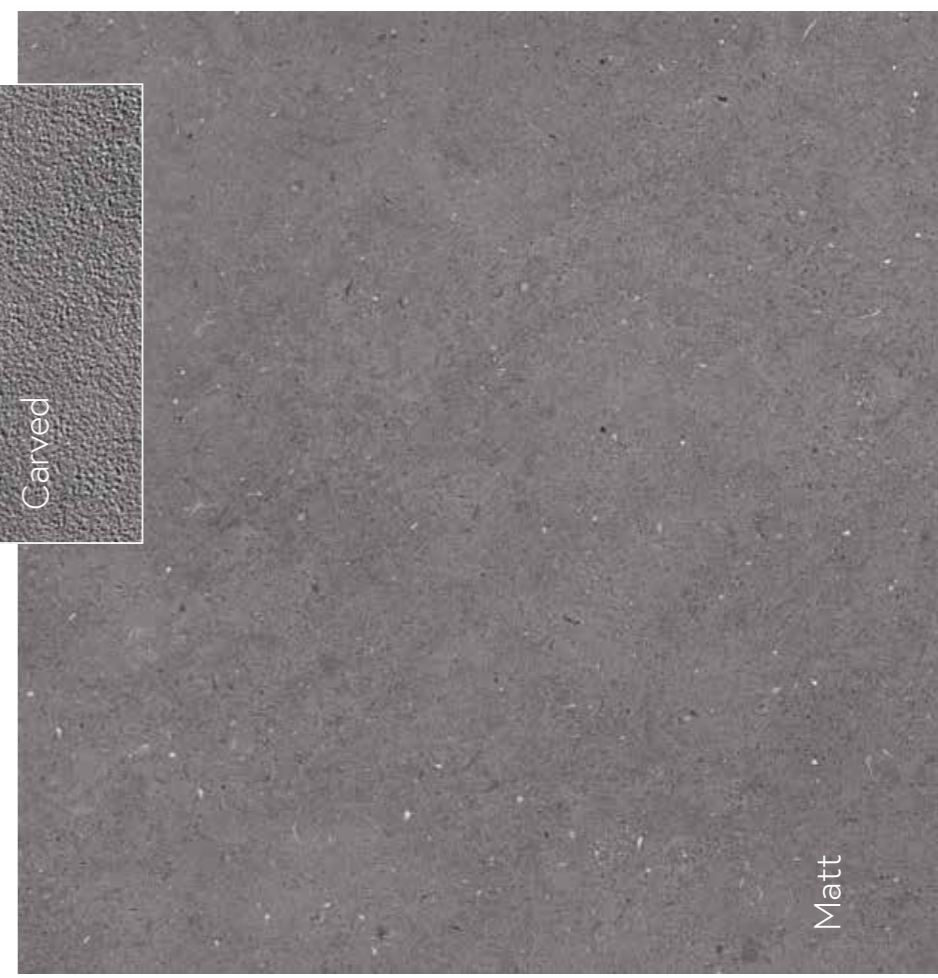

Matt

**Available sizes**  
Formati disponibili

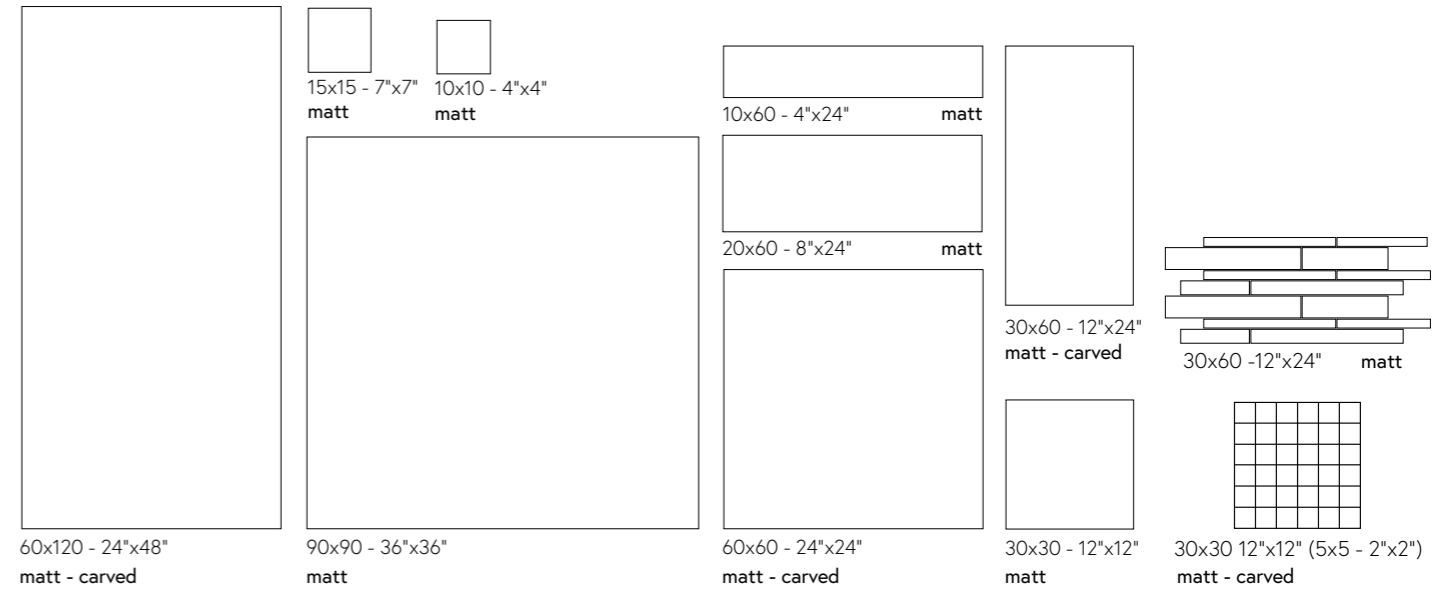



**Lagom**  
floor Graphite 90x90 - 36"x36"

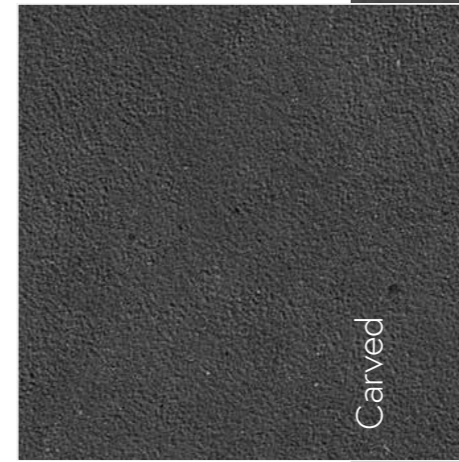

# CHARCOAL

Carved

Matt

## Available sizes Formati disponibili

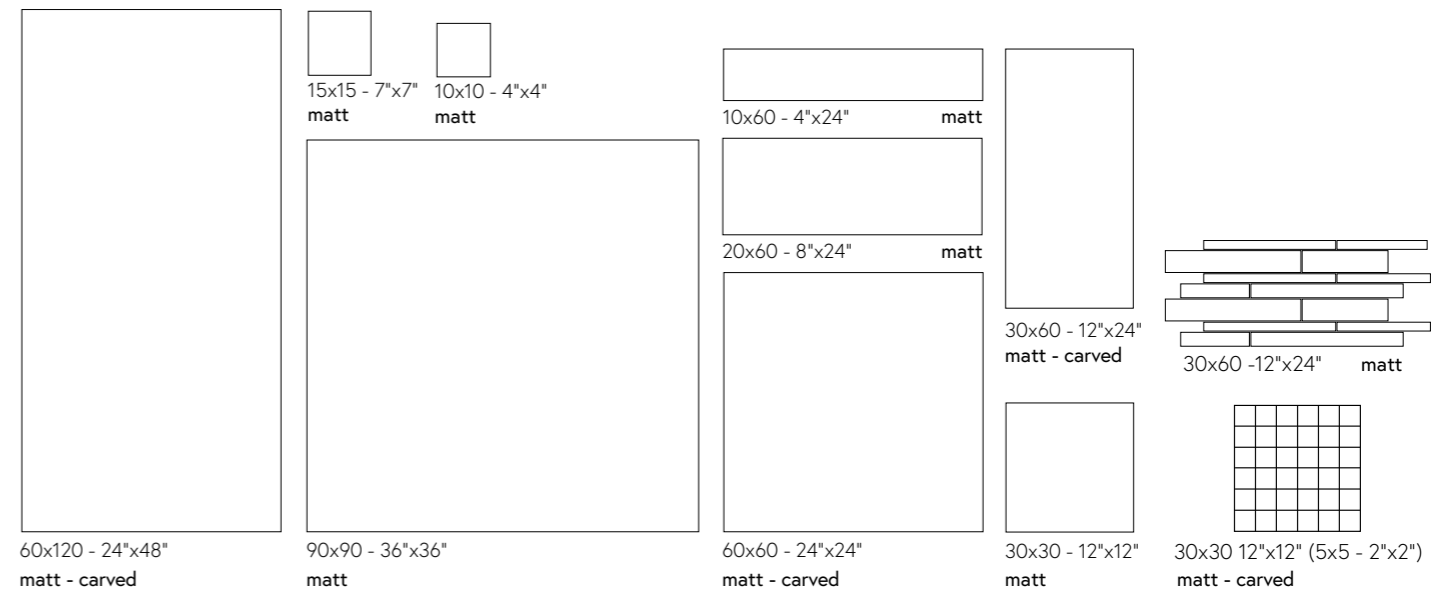





**Lagom**  
floor Charcoal 60x120 - 24"x48"  
**Lagom Curvy**  
counter Charcoal 10x30 - 4"x12"

**Lagom**  
floor Charcoal 60x60 - 24"x24"  
wall Hexa mosaic Cadet Blue 31,6x31,6 - 12"x12"





**Lagom Curvy**  
wall White 10x30 - 4"x12"

## **CURVY** 10x30 - 4"x12"

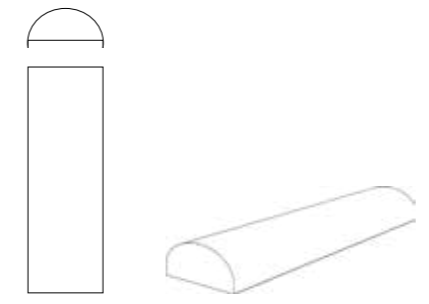

**Material Materiale**  
Extruded white ceramic body - Pasta bianca ceramica estrusa

**Production Produzione**  
Handcrafted - Artigianale

**Technology Tecnologia**  
Embossed - Struttura

**Finish Finitura**  
Matt

**Thickness Spessore**  
30mm



**Lagom Curvy**  
wall Oyster 10x30 - 4"x12"  
floor Oyster 90x90 - 36"x36"



**Lagom Curvy**  
wall Oyster 10x30 - 4"x12"



**Lagom Terrazzo**  
wall Cloud 60x60 - 24"x24"  
floor Smoke 90x90 - 36"x36"

**Terrazzo**

## TERRAZZO



Sun

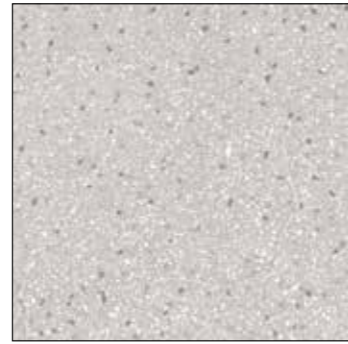

Cloud

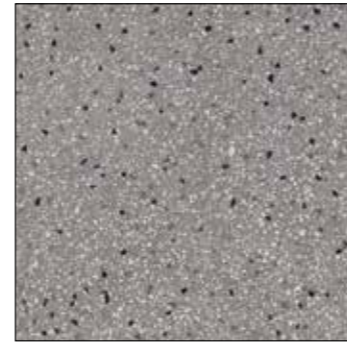

Storm

Thickness | Spessore  
10mm R10

<sup>EN</sup>The Terrazzo technique, which can be considered one of the macro-trends of recent years, is perfectly in line with the growing interest in all that is “pattern”. A poor born material, coming as a cement agglomerate of stone and marble scraps, it takes us back to the Italian history of the 1970s, made up of prestigious floors in Venetian palaces as well as simple floors in the residential homes of the time. A process we chose for the Lagom collection to “decorate” in a minimalist style, creating a retro and contemporary aesthetic at the same time, perfect for designing welcoming and balanced spaces in terms of both colour and style.

<sup>IT</sup>La lavorazione a Terrazzo, che può considerarsi uno dei macrotrend degli ultimi anni, è perfettamente in linea con il crescente interesse verso tutto ciò che è “pattern”. Un materiale nato povero come agglomerato cementizio di scarti di pietre e marmi, ci riporta alla storia italiana degli anni '70, fatta di prestigiosi pavimenti dei palazzi veneziani così come di semplici pavimenti delle case residenziali del tempo. Una lavorazione che abbiamo scelto per la collezione Lagom per “decorare” in stile minimal creando un'estetica retrò e contemporanea al tempo stesso, perfetto per creare spazi accoglienti ed equilibrati sia per colore che per stile.

Rectified and modular  
Rettificati e modulari

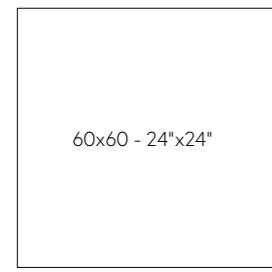

Matt

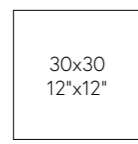

Matt

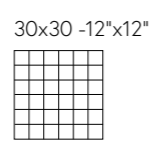

30x30 - 12"x12"

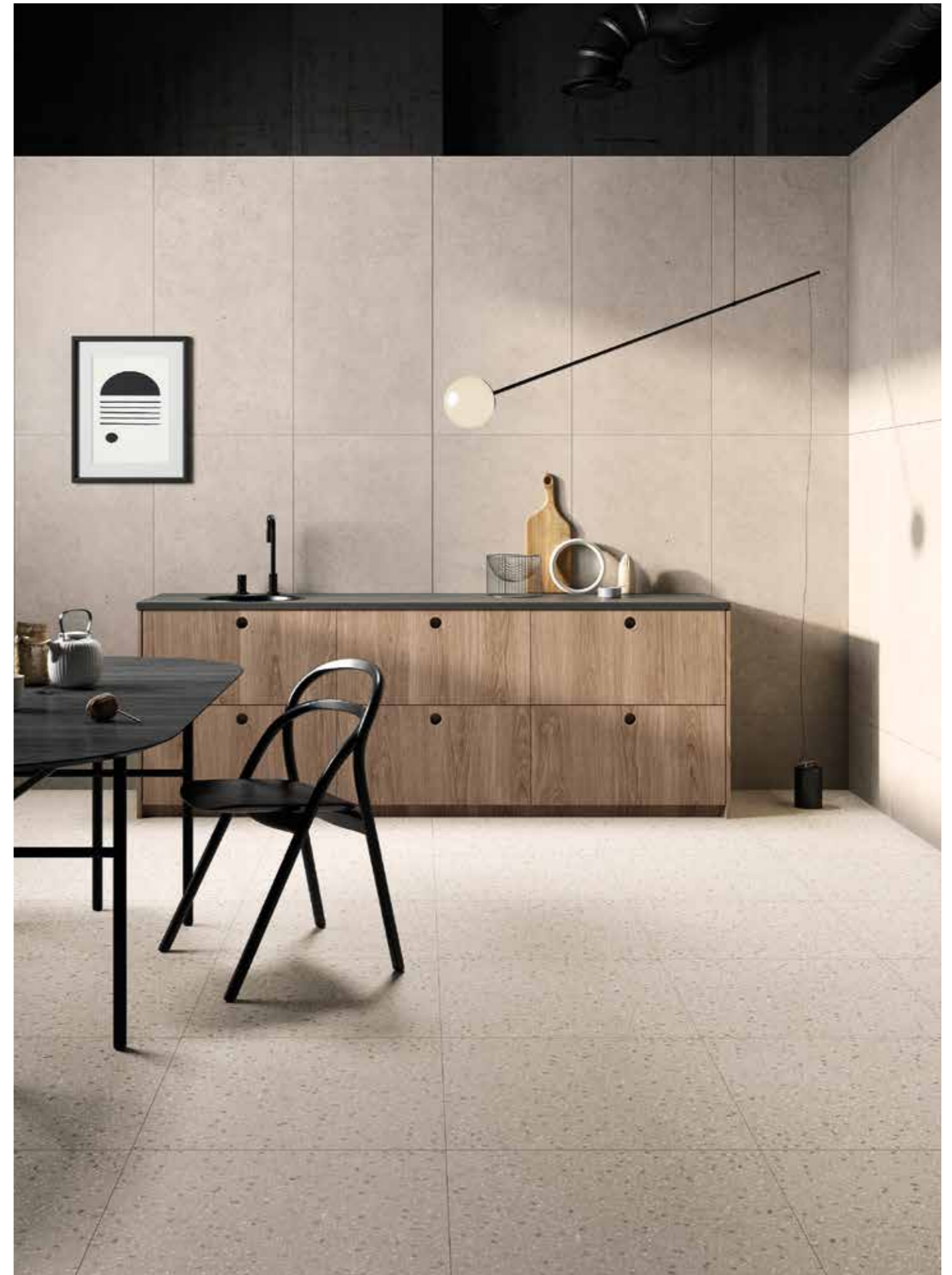

Lagom  
wall Oyster 60x120 - 24"x48"  
floor Lagom Terrazzo Sun 60x60 - 24"x24"



**Lagom Terrazzo**  
floor Cloud 60x60 - 24"x24"



**Lagom Terrazzo**  
floor Storm 60x60 - 24"x24"  
wall Micromosaics Black 30x30 - 12"x12"

Outdoor

THICK<sub>20mm</sub>

**Lagom**  
floor Beige 90x90 - 36"x36"



# LAGOM THICK<sup>20mm</sup>

Ultra matt R11

Thickness | Spessore  
20mm



Beige



Oyster



Smoke

**Rectified and modular**  
Rettificato e modulare

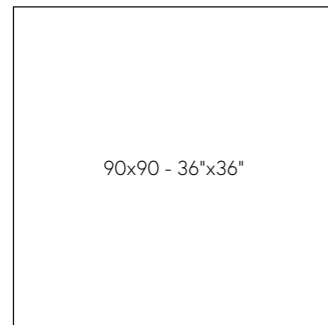

90x90 - 36"x36"



**Lagom**  
floor Smoke 90x90 - 36"x36"





**Lagom**  
floor Oyster 90x90 - 36"x36"

**atmosfera**  
The unexpected feel

MODELLI  
MODELLI

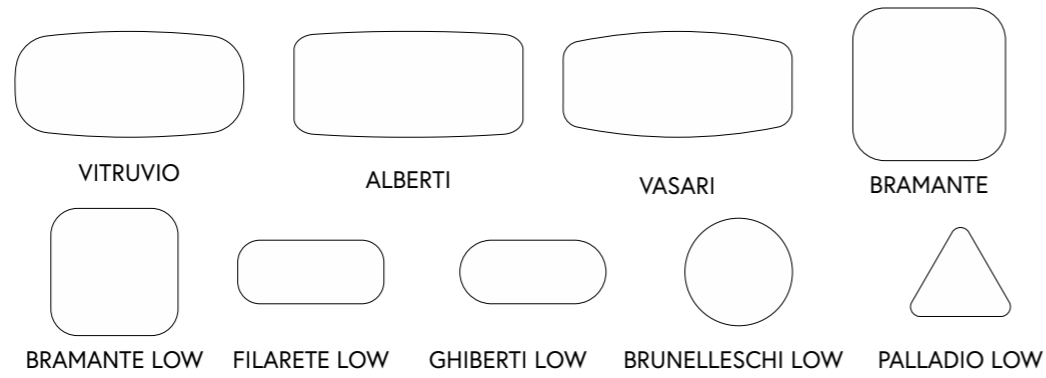

CERAMIC TOP  
TOP IN CERAMICA

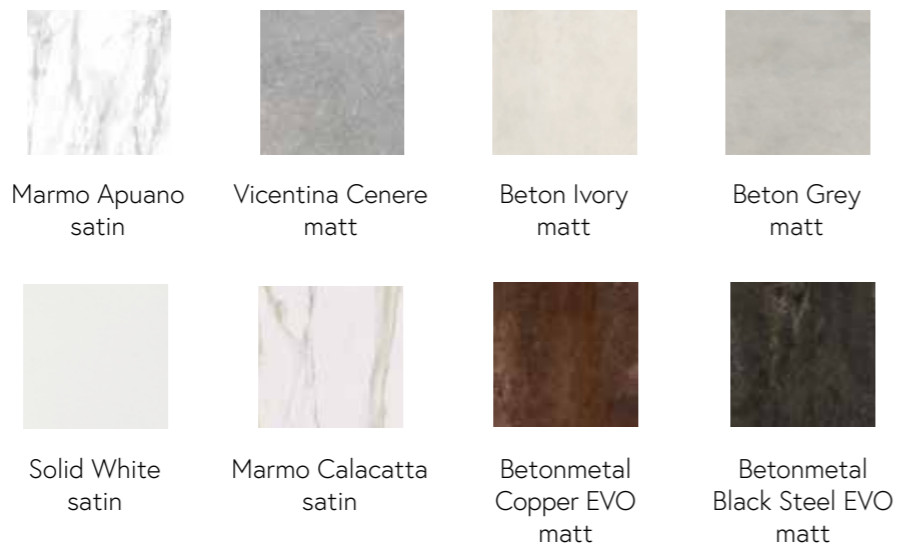

WOODEN STRUCTURE  
STRUTTURA IN LEGNO

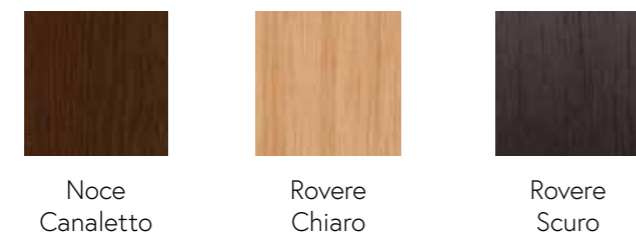

Marmo Apuano



Vicentina Cenere



Beton Ivory



Beton Grey



Solid White



Marmo Calacatta



Betonmetal Copper EVO



Betonmetal Black Steel EVO



■  
Noce  
Canaletto



■  
Rovere  
Chiaro



■  
Rovere  
Scuro



**Lagom**  
floor White 60x60 - 24"x24"



**Lagom**  
floor White 60x60 - 24"x24"



# NEO CLAS SICO

**atmosfera**  
The unexpected feel

MODEL  
MODELLO

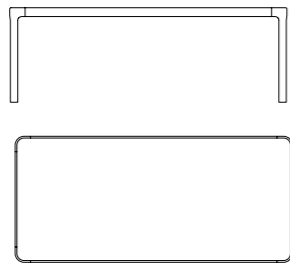

CERAMIC TOP  
TOP IN CERAMICA



Marmo Apuano  
satin



Vicentina Cenere  
matt



Beton Ivory  
matt



Beton Grey  
matt

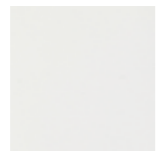

Solid White  
satin



Marmo Calacatta  
satin



Betonmetal  
Copper EVO  
matt



Betonmetal  
Black Steel EVO  
matt

WOODEN STRUCTURE  
STRUTTURA IN LEGNO



Noce  
Canaletto



Rovere  
Chiaro



Rovere  
Scuro

# BASI LICA

MODEL  
MODELLO

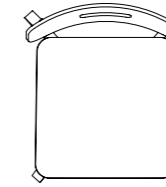
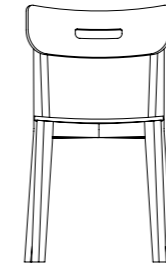

WOODEN STRUCTURE  
STRUTTURA IN LEGNO



Rovere  
Chiaro



Noce  
Canaletto



Rovere  
Scuro



FABRIC  
TESSUTO



Chemistry  
LDS35

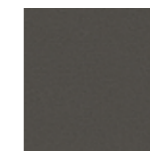

Hook  
LDS29



Serendipity  
LDS08



**Lagom**  
floor Beige 90x90 - 36"x36"



# Hexa

matt 31,6x31,6 - 12"x12"

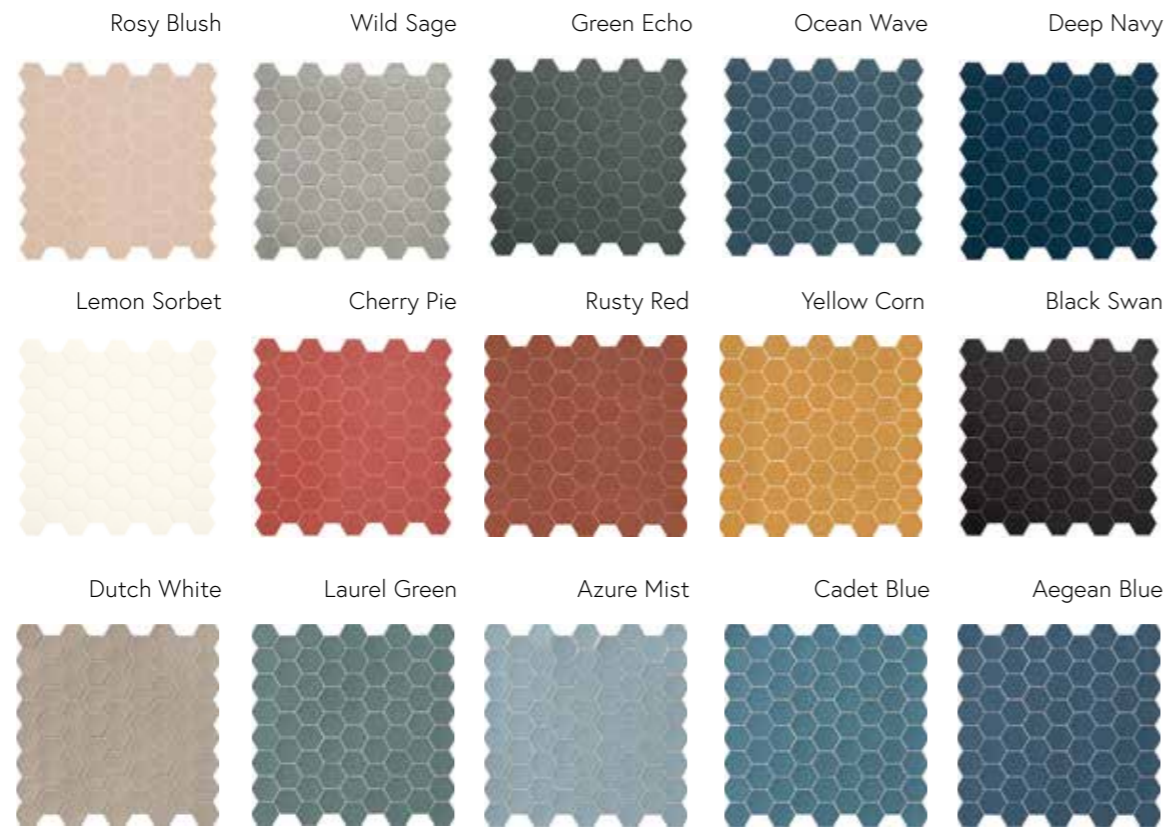

matt - glaze - fabric 31,6x31,6 - 12"x12"

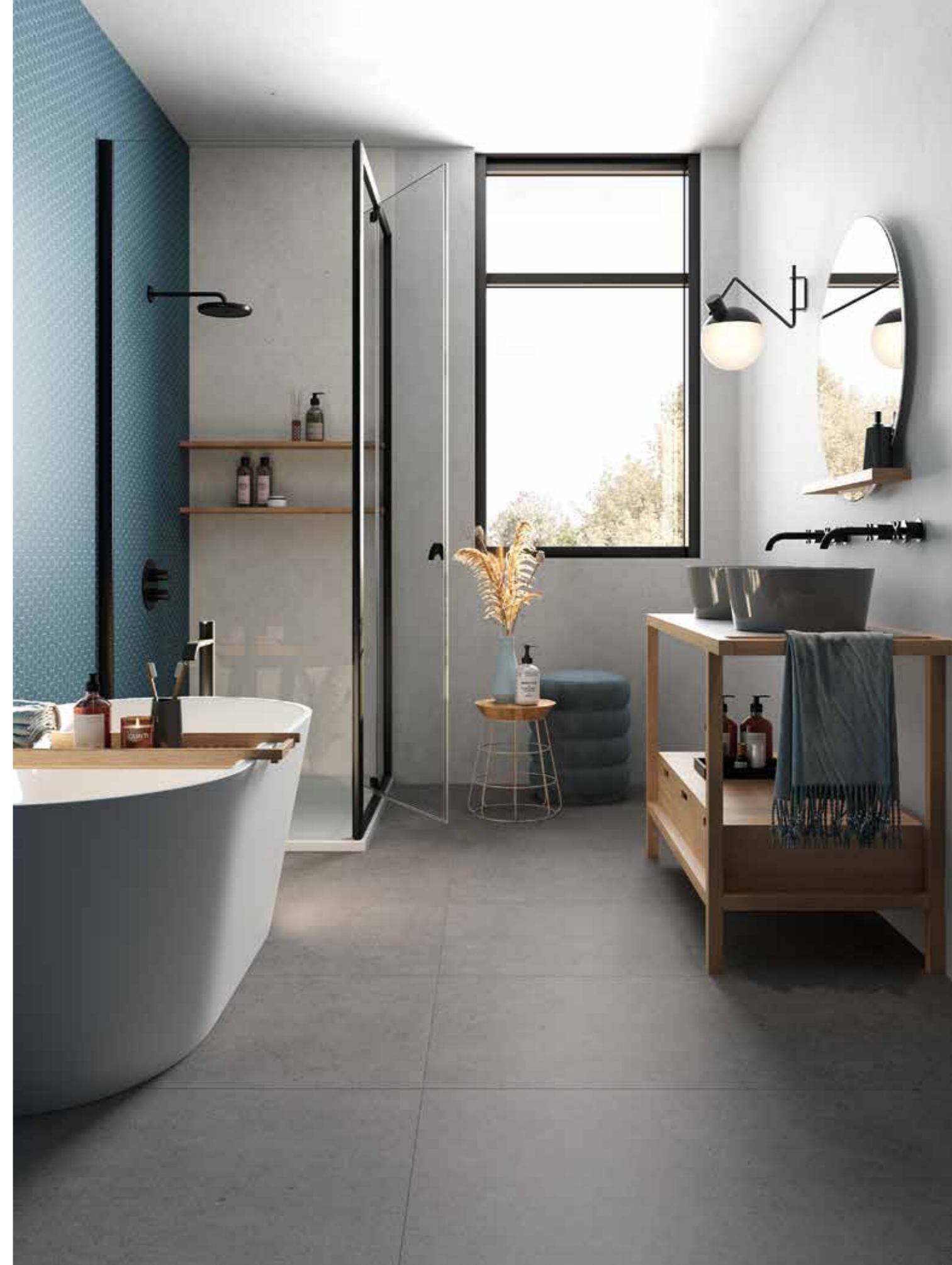

**Lagom**  
 shower White 90x90 - 36"x36"  
 floor Graphite 60x120 - 24"x48"  
 wall Hexa mosaic Cadet Blue 31,6x31,6 - 12"x12"

**Lagom**

floor Beige 60x60 - 24"x24"  
wall Micromosaics Sand 30x30 - 12"x12"



**Micromosaics**

matt 30x30 - 12"x12"

**Micro.**

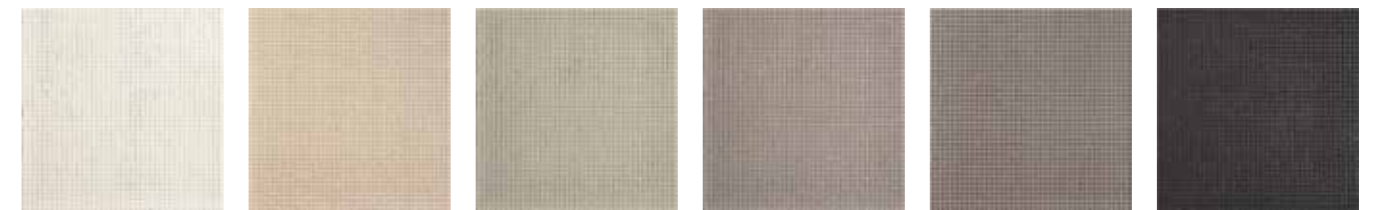

IF010  
White

IF020  
Sand

IF300  
Dust

IF040  
Grey

IF500  
Mud

IF070  
Black

in combination with **LAGOM**

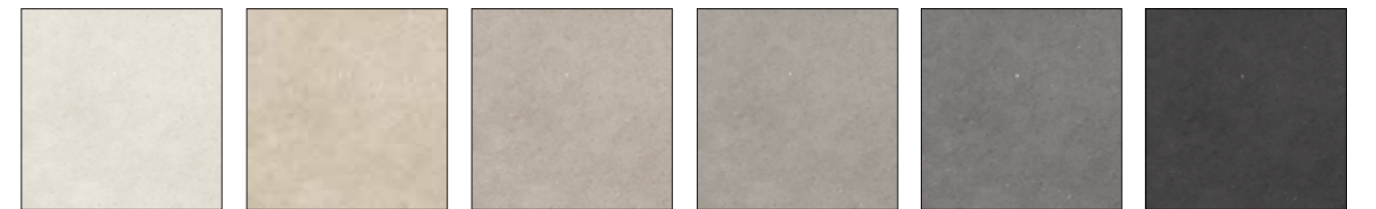

White











Beige

Oyster

Smoke

Graphite

Charcoal

		BOX			PALLET		
		PZ   PCS	SQ.MT.	KG	BOXES	SQ.MT.	KG
	60x120 - 24"x48" matt - carved	2	1,44	30,00	32	46,08	980
	90x90 - 36"x36" matt	2	1,62	35,00	20	32,40	720
	90x90 - 36"x36" <b>TH/CK</b> <sub>20mm</sub> matt	1	0,81	37,30	30	24,30	1139
	60x60 - 24"x24" matt   carved	3	1,08	23,55	40	43,20	962
	30x60 - 12"x24" matt   carved	6	1,08	23,55	40	43,20	962
	30x30 - 12"x12" matt	11	1,00	21,80	48	48,00	1066
	20x60 - 8"x24" matt	8	0,96	20,95	48	46,08	1026
	10x60 - 4"x24" matt	15	0,90	19,65	40	36,00	806
	15x15 - 7"x7" matt	44	1,00	21,80	48	48,00	1066
	10x10cm - 4"x4" matt	50	0,50	10,90	50	25,00	565
	mosaic 30x60 12"x24" matt	6	1,08	23,25	30	32,40	718
	mosaic 30x30 (5x5) 12"x12" (2"x2") matt   carved	11	1,00	21,50	30	30,00	665
	<b>TERRAZZO</b> 60x60 24"x24" matt	3	1,08	23,55	40	43,20	962
	<b>TERRAZZO</b> 30x30 12"x12" matt	11	1,00	21,80	48	48,00	1066
	<b>TERRAZZO</b> mosaic 30x30 (5x5) 12"x12" (2"x2") matt	11	1,00	21,50	30	30,00	665
	<b>CURVY</b> 10x30 4"x12" matt	12	0,36	4,50	60	21,60	290
	skirting 7x60cm - 3"x24" matt	14	8,4ml	14,00	-	-	-
	skirting 5x90 - 2"x36" matt	12	10,8ml	12,00	-	-	-



valid for **LAGOM matt | carved | ultra matt**

## Technical features

Caratteristiche tecniche

TECHNICAL FEATURES UNGLAZED PORCELAIN STONWARE  
CONFORMING TO EUROPEAN STANDARDS EN 14411 ISO 13006 APP. G (GROUP BIA UGL WITH  $E_b \leq 0,5\%$ )

CARATTERISTICHE TECNICHE GRÈS PORCELLANATO NON SMALTATO Conformi a Norme Europee EN 14411 ISO 13006 App. G (Gruppo Bia UGL con  $E_b \leq 0,5\%$ )  
TECHNISCHE EIGENSCHAFTEN UNGLASIERTES FEINSTEINZEUG Gemäß den Europäischen Normen EN 14411 ISO 13006 App. G (Gruppe Bia UGL mit  $E_b \leq 0,5\%$ )  
CARACTERISTIQUES TECHNIQUES GRÈS CERAME NON ÉMAILLÉ Conformes aux Normes Européennes EN 14411 ISO 13006 App. G (Groupe Bia UGL avec  $E_b \leq 0,5\%$ )



TECHNICAL FEATURES CARATTERISTICHE TECNICHE TECHNISCHE DATEN CARACTERISTIQUE TECHNIQUE	TESTING METHOD METODICA DI PROVA PRÜFVERFAHREN NORME D'ESSAIS	REFERENCE STANDARD RIFERIMENTO NORMA STANDARDWERT RÉFÉRENCE NORME	TEST RESULTS VALORE PRODOTTO PRODUKT WERTE VALEUR PRODUIT
<p>Sizes Dimensioni Abmessungen Dimensions</p>	EN ISO 10545-2	<p>N <math>\geq</math> 15 cm</p> <ul style="list-style-type: none"> <li>Length and width - Lunghezza e larghezza - Länge und Breite - Longueur et largeur <math>\pm 0,6\%</math> <math>\pm 2,0</math> mm</li> <li>Thickness - Spessore - Stärke - Epaisseur <math>\pm 5,0</math> <math>\pm 0,5</math></li> <li>Linearity - Rettilineità spigoli - Kantengeradheit - Rectitude des arêtes <math>0,5</math> <math>\pm 1,5</math></li> <li>Wedging - Ortogonalità - Rechtwinkligkeit - Orthogonalité <math>\pm 0,5</math> <math>\pm 2,0</math></li> <li>Warpage - Planarità - Ebenförmigkeit - Planéité <math>0,5</math> <math>\pm 2,0</math></li> <li>Appearance: percentage of acceptable tiles, per lot Aspetto: percentuale di piastrelle accettabili nel lotto Oberflächenbeschaffenheit: Prozentsatz der Fliesen, die den geforderten Eigenschaften entsprechen Aspect: pourcentage de carreaux acceptables sur la fourniture totale 95% min. -</li> </ul>	Compliant Conforme Erfüllt Conforme
<p>Water absorption Assorbimento d'acqua Wasseraufnahme Absorption d'eau</p>	EN ISO 10545-3	$E_b \leq 0,5\%$	Compliant Conforme Erfüllt Conforme
<p>Modulus of rupture Resistenza alla flessione Biegezugfestigkeit Résistance à la flexion</p>	EN ISO 10545-4	Medium value 35 N/mm <sup>2</sup> min.	Compliant Conforme Erfüllt Conforme
<p>Breaking strenght Carico di rottura Bruchlast Charge de rupture</p>		sp. > = 7,5 mm: min 1300 N	Compliant Conforme Erfüllt Conforme
<p>Abrasion resistance Resistenza all'abrasione Abriebbeständigkeit Résistance à l'abrasion</p>	EN ISO 10545-6	175 mm <sup>3</sup> max	Average Medio - Mittelwert - Moyenne < 150 mm <sup>3</sup>
<p>Thermal expansion coefficient Coefficiente di dilatazione termica lineare Wärmeausdehnung Coefficient de dilatation thermique linéaire</p>	EN ISO 10545-8	*Declared value Valore dichiarato Angegebener Wert Valeur déclaré	$\leq 9$ MK-1
<p>Thermal shock resistance Resistenza agli sbalzi termici Temperaturwechselbeständigkeit Résistance aux écarts de température</p>	EN ISO 10545-9	*Pass according to ISO 10545-1 Test superato in accordo con ISO 10545-1 Test ueberstanden nach ISO 10545-1 Pv en accord avec norme en 10545-1	Resistant Resistente Widerstandsfähig Résistant
<p>Frost resistance Resistenza al gelo Frostbeständigkeit Résistance au gel</p>	EN ISO 10545-12	*Pass according to ISO 10545-1 Test superato in accordo con ISO 10545-1 Test ueberstanden nach ISO 10545-1 Pv en accord avec norme en 10545-1	Resistant Resistente Widerstandsfähig Résistant
<p>Resistance to low concentrations of acids and alkali Resistenza a basse concentrazioni di acidi e alcali Beständigkeit gegen schwach konzentrierten Säuren und Laugen Résistance à des basses concentrations d'acides et bases</p>	EN ISO 10545-13	*Declared value Valore dichiarato Angegebener Wert Valeur déclaré	From ULA to ULB Da ULA a ULB Von ULA bis ULB De ULA jusqu'à ULB
<p>Resistance to high concentrations of acids and alkali Resistenza ad alte concentrazioni di acidi e alcali Beständigkeit gegen stark konzentrierten Säuren und Laugen Résistance à des hautes concentrations d'acides et bases</p>		*Declared value Valore dichiarato Angegebener Wert Valeur déclaré	From UHA to UHB Da UHA a UHB Von UHA bis UHB De UHA jusqu'à UHB
<p>Resistance to domestic chemicals and additives for swimming pools Resistenza ai prodotti chimici di uso domestico e agli additivi per piscina Beständigkeit gegen chemischen Haushaltsreiniger und Zusatzstoffe für Schwimmbäder Résistance aux prod. chimiques d'usage domestique et additifs pour piscines</p>		UB min.	UA
<p>Stain resistance of unglazed porcelain Resistenza alle macchie di piastrelle non smaltate Fleckenbeständigkeit von unglasierten Fliesen Résistance aux taches des carreaux non émaillés</p>	EN ISO 10545-14	*Declared value Valore dichiarato Angegebener Wert Valeur déclaré	CLASS 5
<p>Colors resistance to light Resistenza dei colori alla luce Lichtbeständigkeit Résistance des couleurs a la lumière</p>	DIN 51094	No noticeable color change. Non devono presentare apprezzabili variazioni di colore. Die Muster dürfen keine sichtbaren Farbveränderungen aufweisen. Ne doivent pas présenter de variations importantes des couleurs.	No alteration after testing Materiale inalterato dopo il test Keine Veränderung nach dem Test Aucune altération relevée
<p>Friction coefficient (Slipperiness) Coefficiente di attrito (Scivolosità) Reibungskoeffizient (Schlupfrigkeit) Coefficient de friction (Glissement)</p>	DIN 51130 ANSI A137.1 (DCOF)	*Declared value Valore dichiarato Angegebener Wert Valeur déclaré	R10 matt R11 carved   ultra matt >0,42

valid for **LAGOM CURVY matt**

TECHNICAL SPECIFICATIONS FOR EXTRUDED CERAMIC TILES  
CONFORMING TO EN 14411 ISO 13006 STANDARDS APP. F (GROUP AIII GL Eb > 10%)





CARATTERISTICHE TECNICHE CERAMICA ESTRUSA Conformi a norme EN 14411 ISO 13006 Appendice F Gruppo AIII GL EB > 10%  
TECHNISCHE EIGENSCHAFTEN STRANGEZOGENEN FLIESEN Gemäß den Normen EN 14411 ISO 13006 Appendix F Gruppe AIII GL EB > 10%  
CARACTÉRISTIQUES TECHNIQUES POUR CARREAUX CÉRAMIQUES EXTRUDÉES Conformes aux normes EN 14411 ISO 13006 Appendice F Groupe AIII GL EB > 10%

## Technical features

Caratteristiche tecniche



V2 MODERATE

	TECHNICAL FEATURES CARATTERISTICHE TECNICHE TECHNISCHE DATEN CARACTERISTIQUE TECHNIQUE	TESTING METHOD METODICA DI PROVA PRÜFVERFAHREN NORME D'ESSAIS	REFERENCE STANDARD RIFERIMENTO NORMA STANDARDWERT RÉFÉRENCE NORME	TEST RESULTS VALORE PRODOTTO PRODUKT WERTE VALEUR PRODUIT
	Water absorption Assorbimento d'acqua Wasseraufnahme Absorption d'eau	EN ISO 10545-3	Eb > 10%	Compliant Conforme Erfüllt Conforme
	Breaking strength Carico di rottura Bruchlast Charge de rupture	UNI EN ISO 10545-4	> 600 N	NPD
	Glaze crazing resistance Determinazione della resistenza al cavillo Glasurhaarrißbeständigkeit Résistance aux taches	UNI EN ISO 10545-11	-	Resistant Resistente Widerstandsfähig Résistant
	Chemical resistance Resistenza ai prodotti chimici Chemikalienbeständigkeit Résistance aux produits chimiques	UNI EN ISO 10545-14 UNI EN ISO 10545-13	*Declared value Valore dichiarato Angegebener Wert Valeur déclaré	Min. class 3 Min. class B



# Lagom är bäst



view the  
**LAGOM**  
collection



"Stay hungry, stay foolish."

S. Jobs 1955-2011

---

**CHANGE** WE CAN  
CHANGE  
HABITS  
**NOT OUR  
PLANET**  
BY  
**TERRATINTA**  
group

*#notaclassicstory*

brand of **Terratinta Group Srl SB**

// 45, via Viazza II Tronco 41042

Fiorano Modenese (MO) Italy

T +39 0536911408

W [terratintagroup.com](http://terratintagroup.com)

 Terratinta Group

 [terratinta\\_ceramiche](https://www.instagram.com/terratinta_ceramiche) //

*#terratintastyle*



PROJECT BY TERRATINTA MKTG LAB  
PRINTED IN ITALY, January 2022  
TERRATINTA CERAMICHE ALL RIGHTS RESERVED

**CHANGE**



DOWNLOAD  
AREA

**terratinta**  
ceramiche

100%  
made in  
Italy